

System Telephone ST 21 S0  
System Telephone ST 21 UP0



## User Instructions

The digital System Phone ST 21 S0 is intended for the connection to an internal S0-Bus of an AGFEO ISDN Telephone System.

The ST 21 S0 may be connected to the following AGFEO ISDN Telephone Systems:

- AS 181, AS 1x, AS 2x from Software 6.3
- AS 281 All-In-One, AS 35, AS 35 All-In-One from Software 7.1
- AS 40 P (P400-1), AS 4000 (P400-1), AS 100 IT (P400 IT), AS 43, AS 45, AS 200 IT from Software 7.1
- all other AGFEO Telephone Systems with a Firmware below 7.1 will emulate the ST 21 as an ST 25 System Phone. Please refer to Page 18 for a description of the functional changes.

The digital System Phone ST 21 UP0 is intended for the connection to an UP0 connection of an AGFEO ISDN Telephone System.

The ST 21 UP0 may be connected to the following AGFEO ISDN Telephone Systems:

- AS 43, AS 45, AS 200 IT from Software 7.5

### Note:

To reduce the power consumption of the internal S0-Bus, you may connect a separate Power Supply Unit to your ST 21 System Phone. The PSU's may be obtained from your Dealer or Distributor AGFEO Order No. 1542431 (identical to Power Supply Unit of the STE 30 / ST40/STE40)!

Information regarding Software Upgrades may be obtained via your Dealer.

AGFEO GmbH & Co. KG will not accept any liability whatsoever for any damages which may be caused by improper use of the ST 21 System Phone.

### Safety Notice:

- Do not work on the extension wiring or connect/disconnect the ST 21 during a thunder storm.
- Install extension wiring of the ST 21 in a manner that it is not walked on or causing anybody to trip over them.
- Ensure that no liquids are allowed to enter the housing of the ST 21 Digital System Phone as otherwise short circuiting may result.

## About this User Guide

This User Manual is valid for the current system firmware available at the time. However, the ST 21 System Phone is controlled from the Telephone System, which means that if the system firmware is changed, then some sections in this manual may become invalid.

This manual contains user instructions for the ST 21 and a brief instruction regarding the system features. A detailed description of features relating to the Telephone System can be found in the accompanying user guide delivered with the Telephone System.

# System Telephone ST 21

## Table of Contents

User Instructions .....	2
Safety Notice: .....	2
About this User Guide .....	2
Table of Contents .....	3
View of Base .....	4
Untangler Connection .....	4
Display Angle .....	5
Registration .....	5
Connection .....	5
Buttons .....	6
Status Display .....	7
Using the Menu/ Status Display .....	7
Programmable Function Buttons (Overview) .....	8
LED - Indication Associated to Function Buttons .....	10
Button Assignment .....	12
"Direct Line" Enabled .....	12
Changing Button Assignment .....	12
"Direct Line" Disabled .....	12
Call Waiting .....	13
Reject a Waiting Call .....	13
Initiate Call Back when free .....	13
Outside Call Pick Up .....	13
Call Pick up from Answering Machine .....	13
Display Call Log .....	14
Do Not Disturb (DND) Programming and Setting .....	14
Select Retrieval of Phone Book Entries .....	14
Telephone Book (Numeric) .....	14
Recent Numbers Redial .....	15
Automatic Redial Function .....	15
Phone Book (Alphabetical) .....	15
Phone Book (Vanity) .....	15
Location .....	16
Cleaning .....	16
Insert Label .....	16
Headset Connection .....	17
Firmware Upgrade .....	17
Change of Operation in Emulation Mode .....	18
Declaration of Conformity .....	19

# System Telephone ST 21

## View of Base

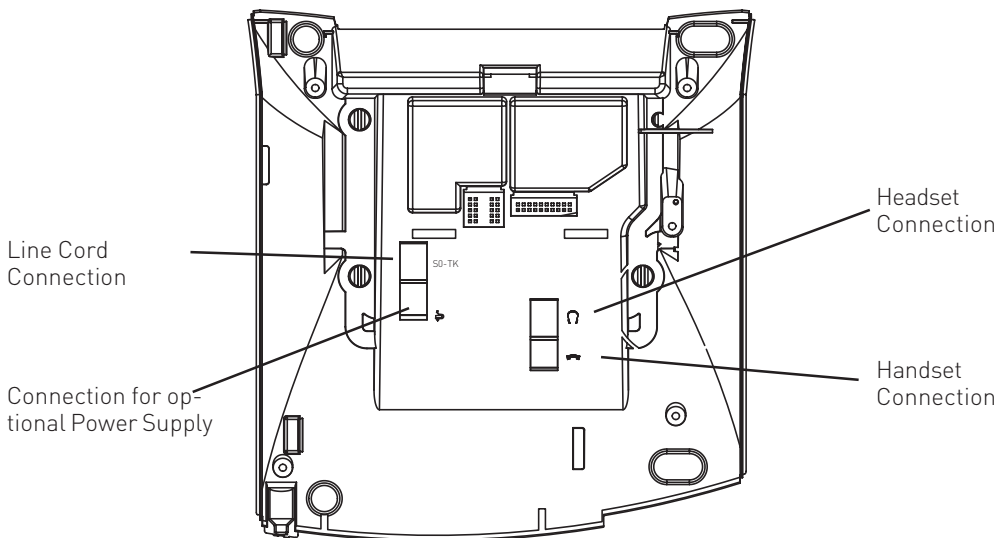

## Untangler Connection

The ST 21 handset offers a compartment for the connection of a cord untangler. As the optional untangler is fitted inside the handset it will not interfere in normal use or when the receiver is put back on hook.

- to open the handset cover , press the lid (arrow 1) and remove lid (arrow 2).
- unplug the handset cord from the handset.
- connect the untangler to the handset.
- connect the handset cable to the untangler.
- close the lid

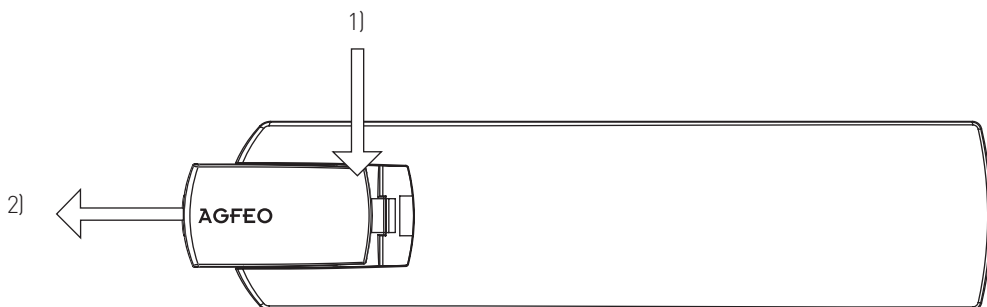

# System Telephone ST 21

## Display Angle

Your Display can be adjusted to 6 different viewing angles.

## Connection

Connect the line cord of the ST 21 into the ISDN telephone socket which is connected to the internal ISDN line of your AGFEO Telephone System.

- insert the RJ 45 plug into the socket until your hear a positive click.
- to release the plug, press the release latch on the plug and at the same time pull the cable out of the socket. (use a small screw driver if required)

To operate the ST 21 UP0, please insert the RJ 45 plug into the ISDN telephone socket which is connected to the UP0 port of your AGFEO Telephone System.

Please note only one telephone can be connected to each UP0 port.

- insert the RJ 45 plug into the socket until your hear a positive click.
- to release the plug, press the release latch on the plug and at the same time pull the cable out of the socket. (use a small screw driver if required)

Please note that the S0 Bus must be terminated with two 100 Ohm ¼ Watt Resistors, the UP0 port does not require any termination.

## Registration

An extension number will be allocated automatically from the telephone system to the ST21 once it is connected to the system, ie plugged into the ISDN telephone socket. If the phone is connected for the first time to the system then it will have to be registered to it. Please follow the instruction in the display of the phone. It may be useful to allocate an extension number to the ST 21 before this is connected to the system by using TK-Suite Set the computer based programming tool.

# System Telephone ST 21

## Buttons

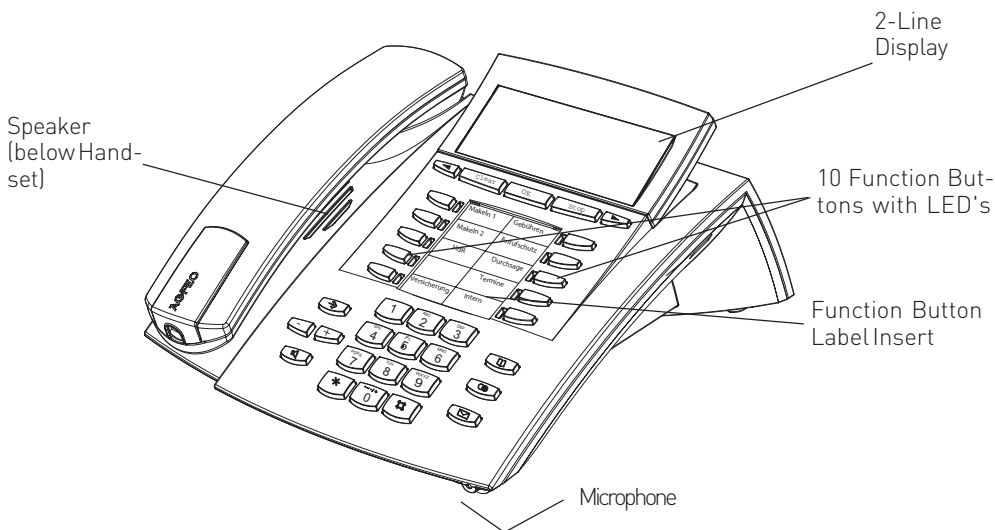

1 0 Numeric Keypad

\* # \* and # Buttons

→ Set Button - Start and end programming. Keep this button pressed to toggle between programming tree and programming index

📞 Handsfree Button - Activates the Loudspeaker. Button lights up when in use.

◀ ▶ Arrow Buttons - To scroll through the display if there is more than one function available.

📞 Phone Book Button - Retrieval of Telephone Numbers.

📞 LNR - Last Number Redial Button. Keep this button pressed to show call log.

✉ Message Waiting LED - Flashes on new entry in the call log or missed call. Permanent lit for numbers already viewed. Clears when number is called or deleted from list by pressing clear button

Clear Clear Button - Clear an entry

OK OK Button - Confirms Entry

Stop Stop Button - disconnect or cancel an action

10 function Buttons - User programmable

+ - Plus and minus for volume adjustment of handset or speaker.

# System Telephone ST 21

## Status Display

Status display of internal and external S0 Bus and analogue lines

Ringing extensions and extensions which are off hook will be displayed reversed.

```
X-i-----          PC#*# 10:28
WK19 TH 11.May      2006
```

Display of enabled features.

### Feature Indication in Display:

- |   |   |    |                                  |
|---|---|----|----------------------------------|
| X | One CO Line (B-Channel or Analogue Line) is in use. Capital X both B-Channels are in use. | C  | Night Service is enabled         |
| i | Internal ISDN line (one B-Channel) is in use. Capital I both B-Channels are in use.       | L  | Telephone Lock is enabled        |
|   | Features:<br>Browse with ◀▶, Select with „ok“   | #  | Wake Up Call is set              |
| W | Call Waiting off  | @  | Appointment on                   |
| * | Do not Disturb (DND) on   | S  | Sensor enabled                   |
| F | Call Forwarding is set  | F  | Call Filter enabled              |
|   |   | I  | Withhold own Number is enabled   |
|   |   | PC | System is being programmed by PC |

## Using the Menu/ Status Display

Please pay attention to the display when using the phone; it will guide you through all available user options. Should the Context Menu be enabled (default setting) then you may select from other functions which will be offered to you in the last line of the display, either before answering a call or during a call.

Selectable features are:

Answer, Park Call, Retrieve, Call Pick Up, Call-Split, Transfer, Call Back, Conference, Enquiry, Reject, Disconnect, Deflect to, Back, Completed and Door-Opener.

The frequently used functions will be offered first. You may browse for additional features, if available by using the arrow buttons ◀▶. To select the displayed function press OK.

# System Telephone ST 21

## Programmable Function Buttons (Overview)

TAM activation	To switch answering machine on or off (optional module)
TAM info	To listen to recorded messages.
TAM Memo	To record memo on the TAM
Reject	Reject an incoming call. Caller will hear busy tone.
Call Waiting on / off	You can select if: Set to off busy tone will be returned if the extension is on another call or off hook. A waiting call should only be visually indicated on your phone. (set to visual) Or if a call waiting tone should also be signalled. (set to audible)
Call Deflection	Will divert an incoming call during the ringing phase. There will be no change to the ringing tone when diverted. The caller will not be aware that the call was forwarded.
Call Filter	To switch Call Filters on or off.
Call Log	Will list unanswered in the Call Log
Cleaning	In connection with the check in / check out button. This can be used to indicate to the front desk that a room has been cleaned and is ready for occupation.
Do not Disturb (DND)	This will disable the Tone Ringer Special function buttons may be set: DND for internal calls DND for external calls DND for internal- and external calls.
Night Service (AVA 2)	Night Service on or off. Special function buttons may be set: Night Service can be switched for each trunk line. Night Service can be switched for all trunk lines.
Call Forwarding	Enable / Disable Call Forward if designated extension does not answer an incoming call. Special function buttons may be allocated: Switch Call Forward for each trunk line. Switch Call Forward for all trunk lines.
Tannoy	Announcement via Public Address Amplifier connected to the Telephone System
Busy on Busy	Returns Busy Tone to Caller if one Extension is Busy within Call Distribution Group. Special Buttons can be assigned -Busy on Busy for each Call Distribution Group switchable separately -Busy on Busy for call Call Distribution Group switchable together
Call by Call	To select Network Provider via LCR
Check In/ Check Out	Check in / Check out for Hotel applications. Will start or stop call logging and switch on or off trunk line access.
Page (Tannoy)	Pageing Announcement to System Phones. Programmable function Button - Page specific Extensions.
Units	Display Call Cost
Call Capture	Malicious Call Identification via ISDN-Exchange
Remote functions	Sending of stored DTMF Tones (1..0 * #) for a remote interrogation of a Telephone Answering Machine (TAM)
Remote Answer	To pick up another ringing extension.
Group Button	Log in or out of Groups and features
Headset	To use a Headset (only Digital System Phones)
Mute Button	To mute microphone on your telephone.



# System Telephone ST 21

## Programmable Function Buttons (Overview)

Call Pick Up	To Pick Up a call ringing on another extension. A Special Function Button may be assigned for this feature.
Withhold	To withhold own number being forwarded to the number called.
Internal Button	To Dial Extensions. Function Button can be assigned to call specific Extension (DSS)
ISDN-Hold	To Hold an external call in the Telephone Exchange (only available on PTMP ISDN lines)
ISDN-Call Forwarding	To set or cancel the ISDN Call Forwarding feature.
Conference	To set up a Conference Call with Internal and or External calls.
Speaker Volume	To adjust Speaker Volume for Handsfree or On Hook use.
LCR	To set or cancel Least Cost Routing (LCR) on your System Phone.
Call Split	To talk to more than one Call in turn without connecting them.
Brokers Call	To talk to one internal and one external call at a time without connecting them.
External	To select a specific number to make an outgoing call on. A function button may be assigned for this feature.
Relays	To activate a Relays. A special function Button may be assigned.
Reserve	To reserve a line should all lines be engaged at the time. (Call Back when free)
Sensor	To Enable or Disable Sensors.
SMS info	Will list all saved SMS messages
Write SMS Message	To write a SMS message.
Enquiry Call	To establish or set up an Enquiry Call
Telephone Book	To select a number out of the System Telephone Book
Telephone Lock	To Lock the Phone. Emergency and direct numbers may be dialled if set.
Appointment	To set or cancel a preset Appointment Time
Timer	To switch on or off a Timed based function, such as Day-Night Service, Call Forwarding, Relays etc. Buttons can be assigned for this function. 20 Multi Function Timers are available.
Doorphone and Lock Release	Function Button can be assigned to connect to the Doorphone. A separate Button can also be assigned to activate the Lock Release.
Transfer	To transfer and connect an external call to an external call.
Diversion from (Follow me)	To divert all calls from another phone to the current phone used.
Diversion to	To divert all calls to another extension- or external number.
Wake Up	To set or cancel a Wake Up Call
Destination Button	To Call a preset Telephone Number
- Public	- A number is stored in the Telephone System Memory
- Private	- A number is only stored in your telephone

# System Telephone ST 21

## LED - Indication Associated to Function Buttons

	LED on	LED off	LED flashes
Answering Machine Messages Call Waiting activation Call Log	Stored messages already listened to. enabled Call Log entries already viewed	No Messages  disabled No numbers in Call Log	New Messages  New Numbers in Call Log
Do Not Disturb Night Service Call Forwarding Busy on Busy Group Button Headset Withhold Number LCR Relays SMS Info	on on set on Logged in active on on on on Messages already read	off off off off Logged out off off off off No Messages	Incomming call  Relay is being rung New Messages
Mute Button Telephone Lock Appointment	enabled on set	disabled off off	when appointment call is ringing
Ringer Off Doorphone and Lock Release Diversion from Diversion to Wake Up	on connected to door phone enabled enabled set	off switched off  disabled disabled off	called from door phone  Unanswered Wake Up Call

# System Telephone ST 21

## LED - Indication Associated to Function Buttons

	<b>LED on</b>	<b>LED off</b>	<b>LED flashes (slow)</b>	<b>LED flashes (fast)</b>
<b>TAM Activation</b>	TAM switched on	TAM switched off		
<b>Extension Button (DSS)</b>	Extension Busy or off hook		The button is allocated to an answering machine <sup>1)</sup> . If it has answered the call, then it can be picked up by pressing this button.	Exclusiv Hold.
<b>Line Button</b>	Line is in use	Line is available to make an outgoing call	Inoming Call	Exclusiv Hold. Call can only be retrieved by the original extension.
<b>Timer Button</b>	Timer is on, function is off	Timer and function is off	Timer and function is on	
<b>Memory Dial Button</b>		Goes off as soon as the call is answered	Flashes on incoming call from that number. Call can be picked up.	

### General information regarding a Line Button.

To have a meaningful presentation of line buttons it is suggested to programm two buttons for each ISDN line (2 B-Channels). By pressing a flashing line button when the phone is iddle will give information of the waiting callers number. Pressing this button when the phone is off hook will connect to the call.

1) Only Answering Machines which are directly connected to an Analogue Extension Line.

# System Telephone ST 21

## Button Assignment

In default all System Phone Buttons are pre-programmed with the same functions.

Functions of each button can be changed to accommodate an individual application.

Announce	Call Waiting
Appointment	Tone Call
Call Filter	Mute
System Memory	Diversion to
System Memory	Internal

## Changing Button Assignment

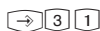

Start Programming



Enter PIN if required



Press Button to program



Enter first letter of function or browse using the arrow buttons.



Confirm Entry



End Programming

## "Direct Line" Enabled

### Calling an Extension:



Lift receiver



Dial # and Extension Number

### Making an Outside Call:



Lift receiver



Dial Number

## "Direct Line" Disabled

### Calling an Extension:



Lift receiver



Dial Extension Number

### Making an Outside Call:



Lift receiver



Dial 0 (or 9) for a Line. Wait for Dial Tone. Dial Number.

# System Telephone ST 21

## Call Waiting

### First Alternative:



You are on a call and hear the call waiting tone.

End Call



Waiting Call will ring



Lift Handset



Speak to Caller

### Second Alternative:



**Press the Button "Call Split or Brokers Call"**. The first call is put on hold and you are connected to the second caller. You now can toggle between the calls or transfer the call.

## Reject a Waiting Call



**Press the Button "Reject"**. The caller will receive busy tone if you are the only ringing extension in the call distribution table. The caller will continue to hear a ringing tone if another extension is in the same call distribution table. Continue conversation

## Initiate Call Back when free



Called extension is busy or does not answer your call



Press **OK**. Call Back when free is initiated. Confirmation tone will be returned.



Replace Handset.

## Outside Call Pick Up



To pick up incoming call.



Pick up Handset. Press **OK** to answer the call.

## Call Pick up from Answering Machine



Incoming call has been answered by the Answering Machine.



Lift Handset, **Press Button "Pick Up Call"**.

NOTE: Only possible if this button has been configured as a DSS button for that extension.

# System Telephone ST 21

## Display Call Log

The handset is on hook. The Message Waiting LED is flashing.

There will be at least one new entry in the Call Log. The Message Waiting LED will flash until the new entries have been displayed, after which the LED will remain lit until you return the call to the displayed number or delete the entry.

Press the message waiting button to display the first entry in the log .

The LCD will display the number, time & date, or a notification to return a call from an extension including time & date.

Further entries may be displayed by using the arrow keys.  



The number displayed will automatically be dialled by lifting the handset. The number logged will automatically be deleted once the call is answered. The number will remain in the call log if the call remains unanswered.

To delete an entry, select the required number and press .

To exit the call log display press .

## Do Not Disturb (DND) Programming and Setting



 "1": DND from Extension Calls Only  
 "2": DND from Incoming Calls  
"3": DND for both



Select the function with the **Button "Set"** and **Button "DND"**.

Exit programming

To set or cancel DND for the pre-selected condition press the DND button.

## Select Retrieval of Phone Book Entries



Press and hold the Phone Book Button for 1 second



Select the desired setting with the arrow keys. (Vanity, Numeric or Alphabetical) confirm selection pressing .

## Telephone Book (Numeric)



Press Phone Book Button Enter the required short code or use the arrow keys to browse to find desired entry.

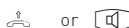

Pick up handset or press "Speaker Phone Button", the telephone number will be dialled automatically and the selected number will be displayed.

# System Telephone ST 21

## Phone Book (Vanity)



Press Phone Book Button Enter the first letter, ie. A=2. The first entry with this letter will be displayed



Select the next letter, ie M = 6. The first entry with "Am" will be displayed

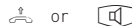

Pick up handset or press "Speaker Phone Button". The selected entry will be dialled.

Browse with arrow keys  

## Phone Book (Alphabetical)



Press Phone Book Button Enter the first letter, ie. A=2. The first entry with this letter will be displayed



Select the next letter, ie N = 66. The first entry with "An" will be displayed

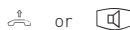

Pick up handset or press "Speaker Phone Button". The selected entry will be dialled.

Browse with arrow keys  

## Recent Numbers Redial



With the handset on hook press the "RedialButton". The last dialled number will be displayed.



Use arrow buttons to select one of the last 10 numbers dialled.



Pick up handset, displayed will be dialled.

## Automatic Redial Function



With the handset on hook press the "RedialButton". The last dialled number will be displayed.



Press  to start the automatic redial feature. The display will show how many attempts the system will try to connect to the number. The loudspeaker will be switched on as soon as a connection has been established.

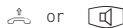

Pick up handset or press the speaker phone button as soon as the caller has answered. Otherwise the call will be disconnected after 20 seconds.

# System Telephone ST 21

## Location

Select a suitable location for the ST 21 to be installed. Please observe the following points:

- Do not use locations where the phone could be subjected to water or chemicals.
- Rubber feet of the Phone:

Your phone has been manufactured for general use. Some chemicals found in furniture polish or other furniture care products may alter the substance of the rubber feet of the phone. Due to this influence it may be possible that the rubber feet of the telephone may leave some marks. We will not accept any liability for any of such occurrences. With reference to new furniture or polished furniture we would suggest to use a non-slip protective matt for your telephone.

## Cleaning

To clean your telephone **use a soft damp cloth**. An antistatic cloth may also be used.

**NEVER use a dry cloth** as this could result in a static discharge which may damage electronic components within the telephone. Please take great care that **NO MOISTURE** will enter the telephone as this will lead to malfunction and ultimately damage the telephone.

## Insert Label

The enclosed label for the ST 21 is printed with the default setting of the function buttons (see Page 7). The reverse of the label can be handwritten if alternative functions have been allocated.

The label can be removed by inserting the finger nail on the top of the plastic insert and housing. Move the insert downwards until it is curved. The label can now be removed.

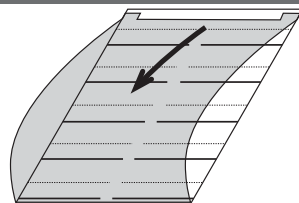

To re-insert the label put the bottom of the clear plastic strip in the bottom slot of the telephone and follow the instruction above in reverse order.

To give a professional appearance, labels can be printed with the programming tool TK-Suite directly from your PC.



# System Telephone ST 21

## Headset Connection

A headset connection can be found underneath the ST 21. (Suitable for RJ 45 or RJ 10 connectors)  
The following corded headsets may be used.

Manufacturer	Description	Manufacturers Order No.
AGFEO	Headset 2100	6548839
	Headset 2200	6548847
Plantronics	Supra Monaural Polaris Modell P51 *	32190-04
	Tristar Modell P81 *	33695-01
	* including Connection Cable U10P	38058-01
GN Netcom	Profile Monaural **	1861-15-03
	Optima NC Monaural **	1913-29-01
	** including Connection Cable	8800-00-01

Note: The headset socket is indicated by a headset symbol. (Further information on Page 4)

- Insert the headset plug into the headset socket until you hear a positive click.
- Push the cord in the cable channel so that it will exit towards the back of the phone.
- To release the headset press the latch on the plug and at the same time pulling the cord out of the socket. If required use a small screwdriver.

## Firmware Upgrade

The firmware of your ST 21 telephone can be upgraded without the need of any hardware changes.  
Please follow the instructions if a firmware upgrade is required:



The handset is on hook and the telephone is idle.



Press the following buttons simultaneously **[\*], [0], [#]**. The ST 21 is now in service mode.



Press **[1]** for Software Update



Enter the telephone number of the Update Server which is: +49 (0)521 44709 950. Depending on the line seizure set, you may have to prefix the number with 0 (9).



Confirm the entry with **[OK]**. The Update Server is now being dialled and the update will begin.

The update will be completed in approx. 90 secs, after which the ST 21 will re-register to the telephone system. The current software will be displayed on the phone on start up. The firmware update is now completed.

# System Telephone ST 21

## Change of Operation in Emulation Mode

The ST21 will be emulated as an ST25 for AGFEO telephone systems with an S0-Bus and firmware lower than 7.1, with the exception of the telephone systems AS 181, AS 2x and AS 2x from firmware 6.3. Due to this the following buttons will change or have no function.

- The „+“ and „-“ Buttons of your ST21 are without function.
- The LED's of the Function Buttons have no indication.
- Up to 9 functions will be available. The first button on the bottom right will be used as a shift key.
- In contrast to the ST25, the ST21 has only one function button level.
- The arrow button are used for „next“ (arrow to right) and „shift next“ (arrow to left).
- The display will feature 16 characters per line.
- „Stop“ will change to the „esc“ button.
- The „ok“ button will serve as „enter“ key.

Further information regarding the use of the ST 25 System Phone can be found in the „User Guide“ of your Telephone System.

### EU-Konformitätserklärung

EC-Declaration of Conformity  
CE-Déclaration de Conformité

**Der Hersteller:** AGFEO GmbH & Co. KG

The Manufacturer:  
Le Constructeur:

**Adresse:** Gaswerkstr. 8  
D - 33647 Bielefeld

Address:  
Adresse:

**Erklärt, dass das Produkt:** ST 21

Declares that the Product:  
Déclare que le Produit:

**Type:** Systemtelefon

**Model:** ST 21

**Components:**

**die grundlegenden Anforderungen gemäß Artikel 3 der nachstehenden EU-Richtlinien erfüllt:**

meets the essential requirements according to article 3 of the following EC-Directive:  
est conforme aux exigences essentielles d' article 3 de la Directive CE:

**Richtlinie 1999/5/EG des Europäischen Parlaments und des Rates vom 09. März 1999  
über Funkanlagen und Telekommunikationsendeinrichtungen und die gegenseitige  
Anerkennung ihrer Konformität**

Directive 1999/5/EC of the European Parliament and of the Council of 09 March 1999 relating to radio and  
telecommunications terminal equipment, including the mutual recognition of their conformity  
Directive 1999/5/CE du Parlement européen et du Conseil du 09 mars 1999 concernant les radio et équipement terminaux de  
télécommunications, incluant la reconnaissance mutuelle de leur conformité

**und dass die folgenden harmonisierten Normen angewandt wurden:**

and that the following harmonised standards has been applied:  
et que les standards harmonisés suivants ont été appliqués:

EN 55022/2003  
EN 55024/2003

Bielefeld, 22. Mai 2006

**Ort und Datum der Konformitätserklärung**  
Place and date of the declaration Lieu et date de la déclaration

Phone : +49(0)5 21 44 70 9-0  
FAX : +49(0)5 21 44 70 9-50

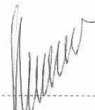

**Name und Unterschrift**  
Name and Signature Nom et Signature

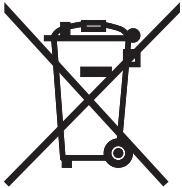

The crossed out wheeled bin on the product means that this belongs to the group of Electro- and electronic apparatus.

In this context you are directed by the European regulation to dispose of used apparatus

- at the point of buying an item of equal proportion / value
- at the local available collection point for disposal

With this you will participate in the reuse of material and valorisation of disused electric- and electronic apparatus, which otherwise could be a health hazard and be negative to the environment.



Ident no. 1101372

Subject to change without notice. No liability can be accepted for errors contained in this document.

Printed in Germany  
1060

**AGFEO** GmbH & Co. KG

Gaswerkstr. 8

D-33647 Bielefeld

Internet: <http://www.agfeo.com>